

Specifications:

Sound level Category	Medium Sound Level
Mode of Operation	Warble
Mounting	Panel (see note B)
Voltage Rating	6 to 30 Vdc
Frequency	1800 Hz \pm 500 Hz to 2800 Hz \pm 500 Hz
Loudness (Min. Voltage)	65 dB(A) min. @ 2 FT and 6 Vdc
Loudness (Max Voltage)	85 dB(A) min. @ 2FT and 30 Vdc
Sweep Rate Min. (PPS)	0.5 @ 6 Vdc
Sweep Rate Max. (PPS)	2.0 @ 30 Vdc
Current Draw	6 mA Max @ 6 Vdc
Current Draw	35 mA Max @ 30 Vdc
Storage Temperature	-40°C to +85°C
Operating Temperature	-30°C to +65°C
Weight (Typical)	2.1 oz (59 g)
Housing	6/6 Nylon, Color Black
Options	For other options contact factory

Dimensions: Inches (mm)

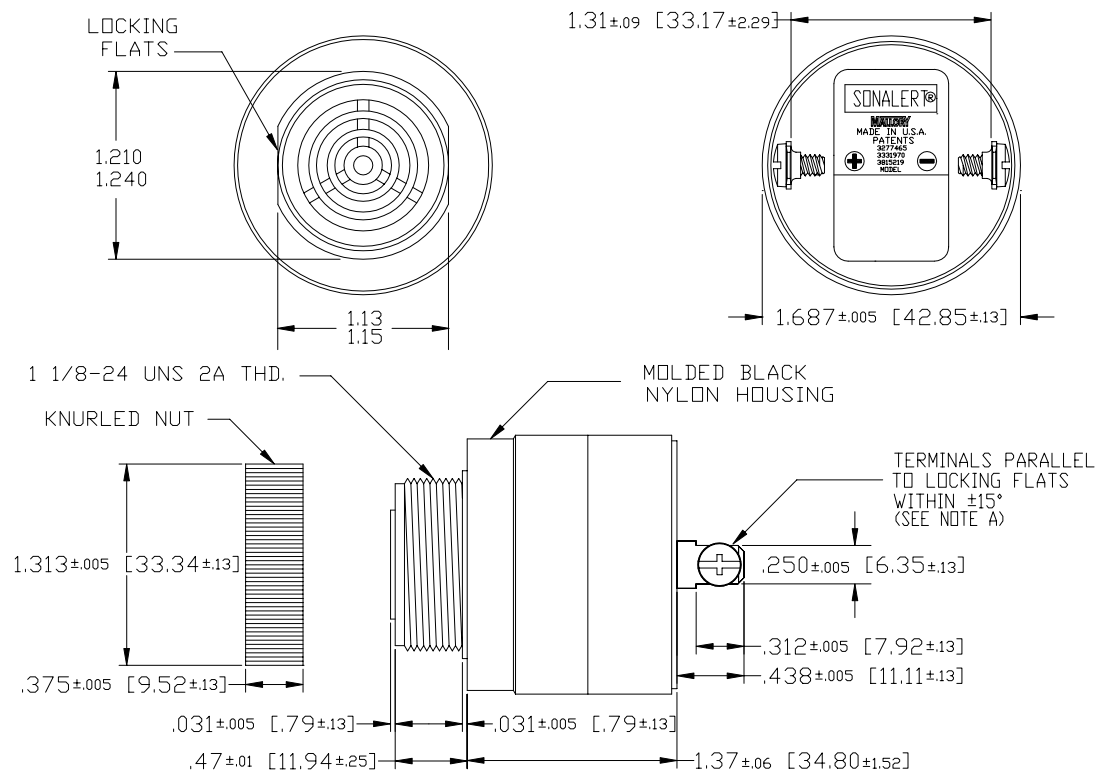

NOTE A: TERMINALS-.032 BRASS TIN PLATED, TAPPED FOR #6-32 SCREW. TWO #6-32 NICKEL PLATED BRASS SCREWS INCLUDED. WILL ACCEPT 1/4" QUICK CONNECT.

NOTE B: MOUNTING- REMOVE BLACK PLASTIC NUT AND INSERT THREADED FRONT THROUGH 1.25" HOLE PUNCHED IN PANEL, IF ORIENTATION IS NEEDED, NOTE LOCKING FLATS ON DRAWING. SCREW NUT BACK ON. DO NOT OVERTIGHTEN.